

J j

Learning



- Listen to the story.



Joseph Jellyfish

This is **J**oseph.

Joseph **J**ellyfish likes drinking **j**uice.

He eats bread with **j**am everyday.



- Trace and Write.

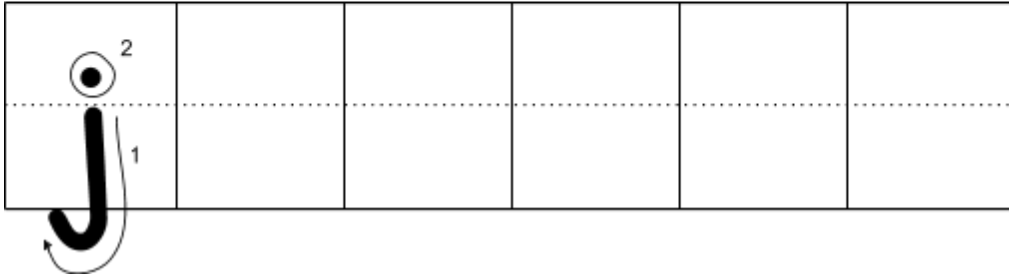
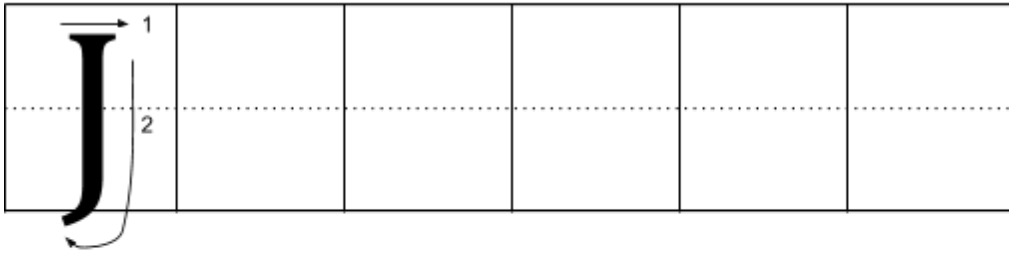

- Listen and Read.

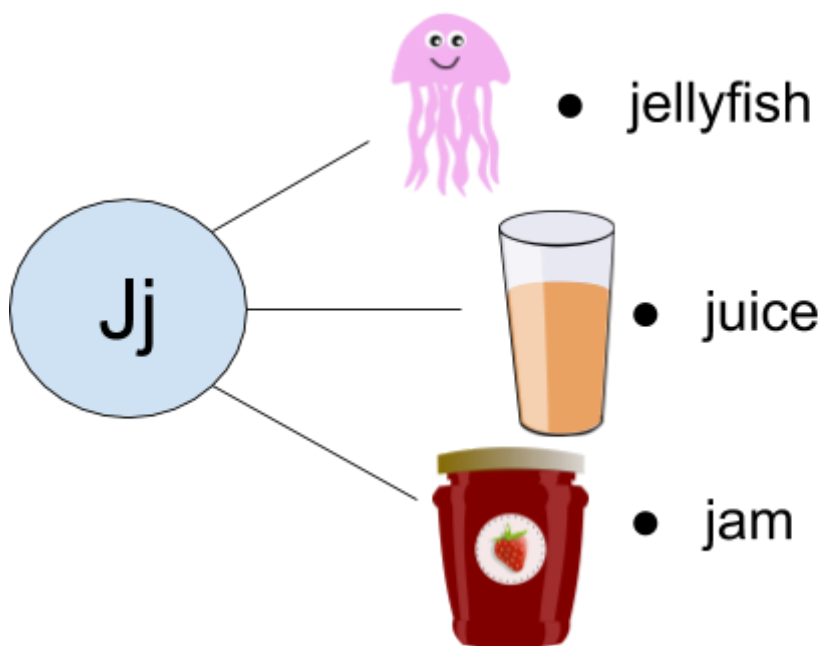

K k



- Listen to the story.



Karl Koala



This is **K**arl.

He is the **k**ing of **k**oala.

He likes playing **k**ite.



- Trace and Write.

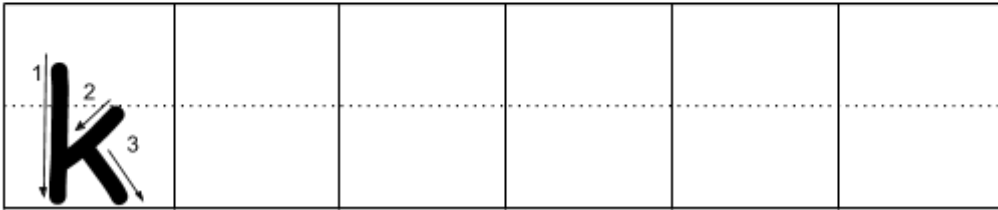
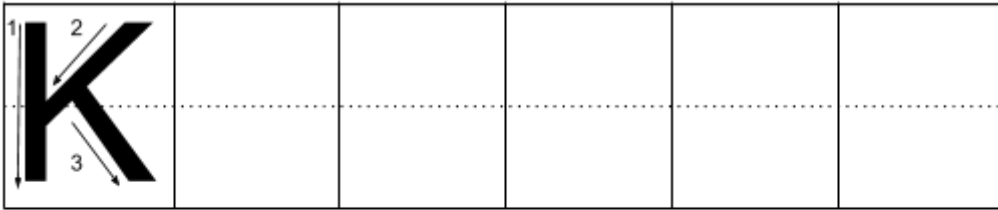

- Listen and Read.

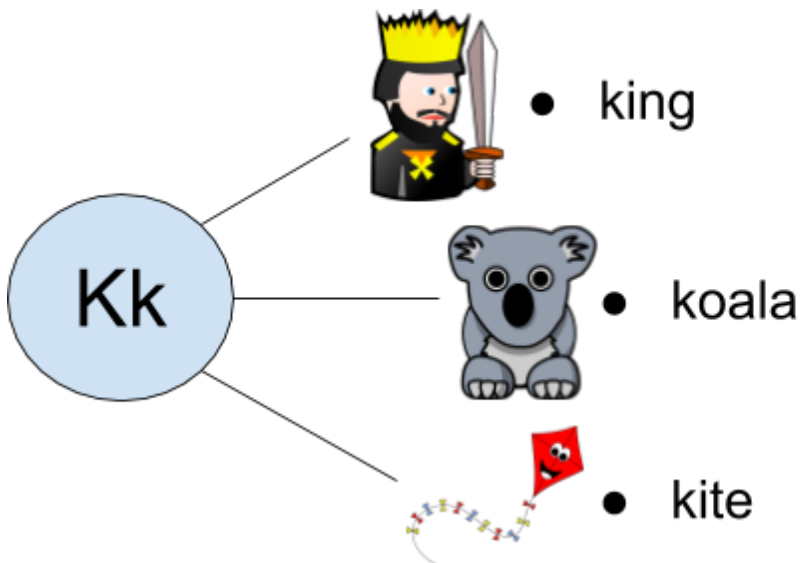

L I



- Listen to the story.

Hi guys, I am Lucas!



Lucas Lion

This is Lucas.

Lion Lucas hates lemon.

He laughs a lot.



- Trace and Write.

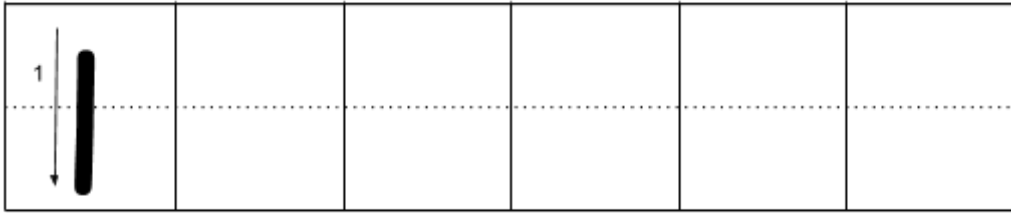
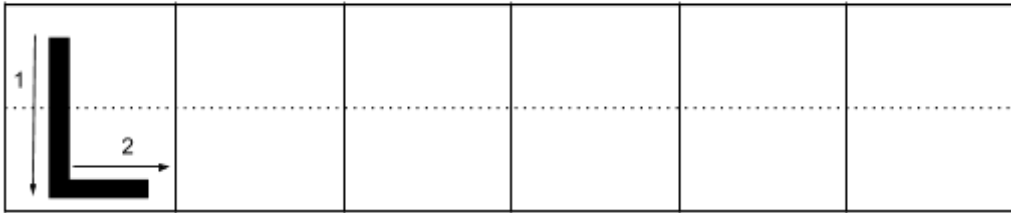

- Listen and Read.

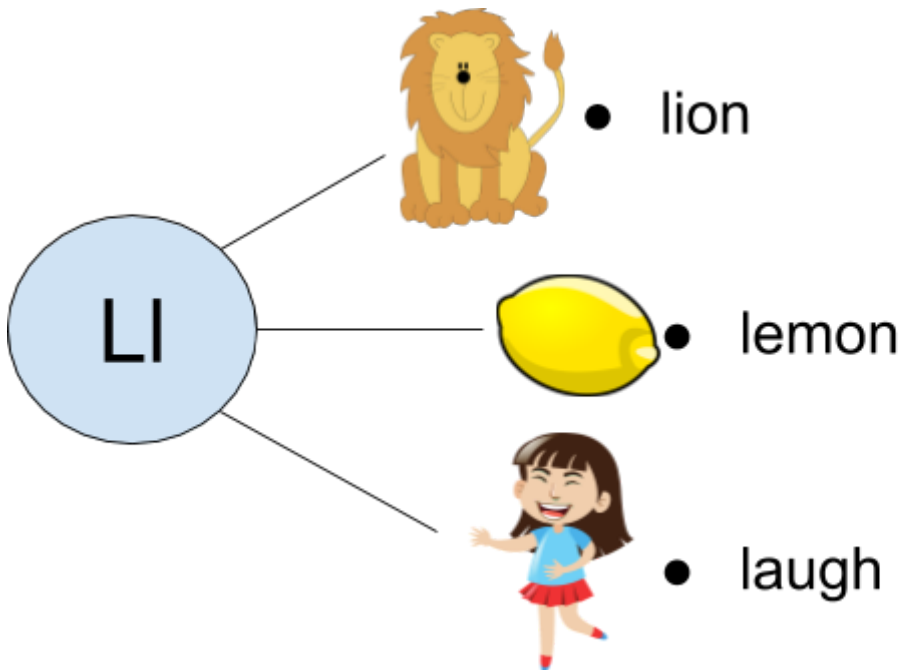

Let's practise.

(A) Match the correct partner letters.

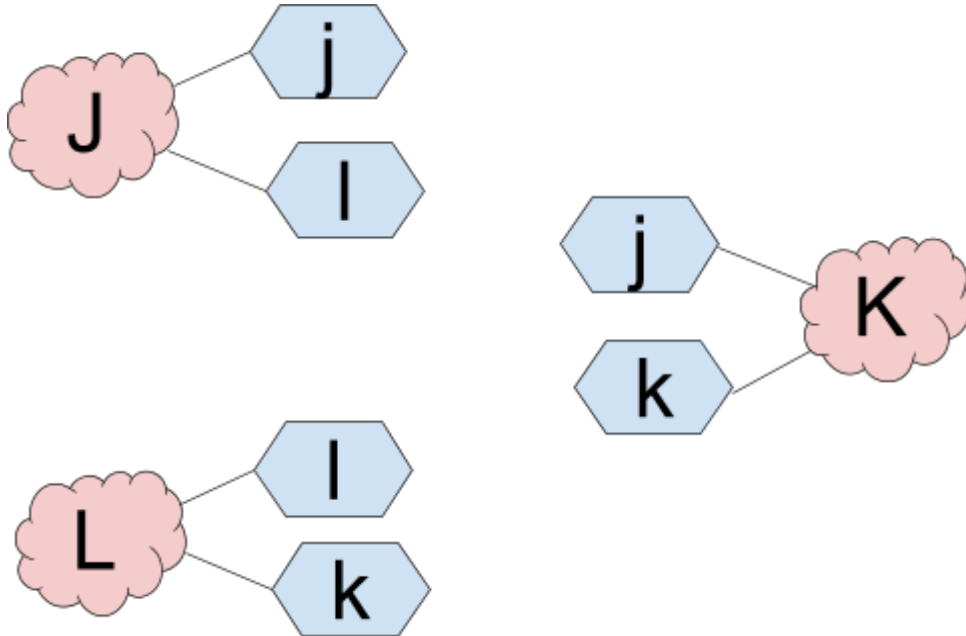

(B) Match the correct beginning sound.

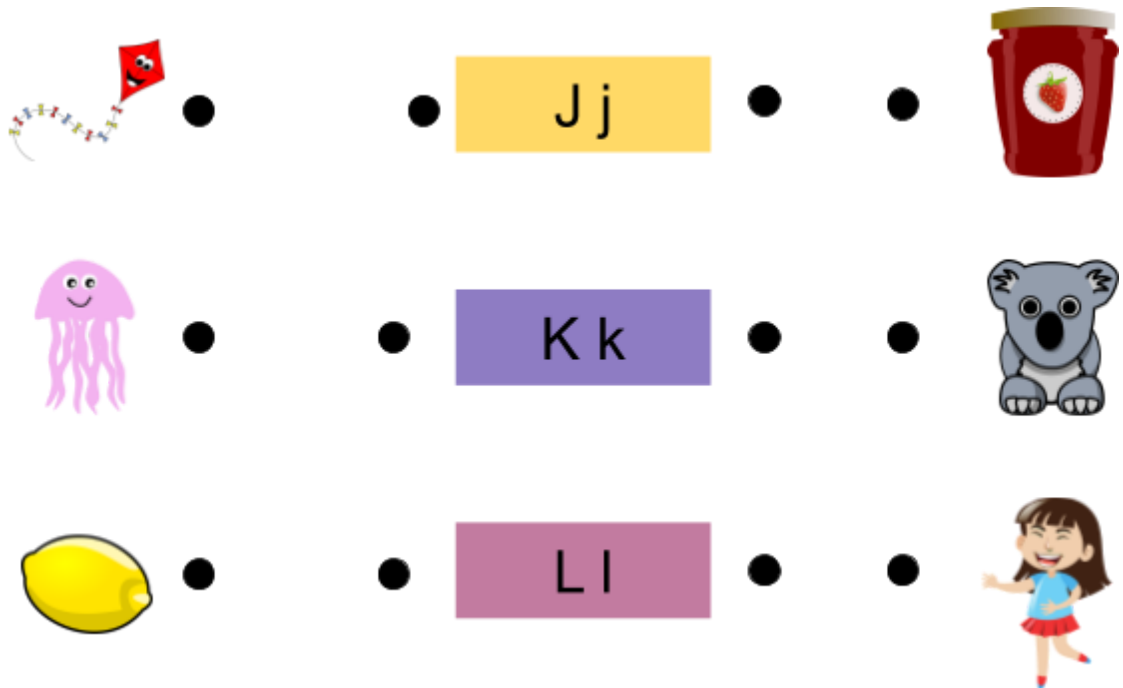

(C) Colour the pictures with the corresponding beginning sound.

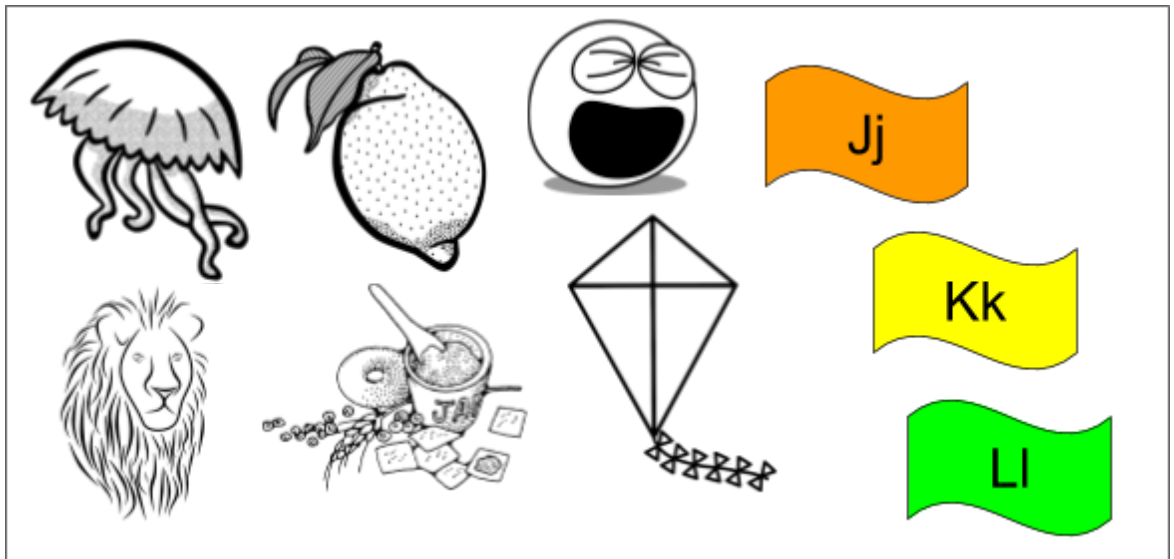

(D) Read and Circle the correct picture.

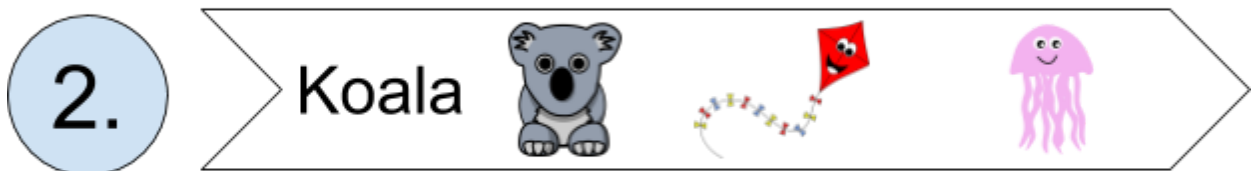

(E) Listen and Circle the corresponding word and picture.

juice  lemon  kite 

lion  jam  koala 

king  jellyfish  kite 

Let's have fun.

- Draw and write

Eg



Jam



Jelly



__ellyfish



J_____



__ite



K_____



__augh



L_____