

Learning

A a



- Listen to the story.



Angel Alligator

This is **A**ngel.
Angel **A**lligator.
She likes **a**pple.



- Trace and Write.

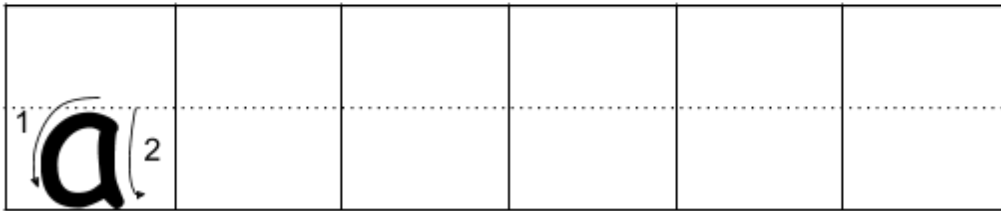
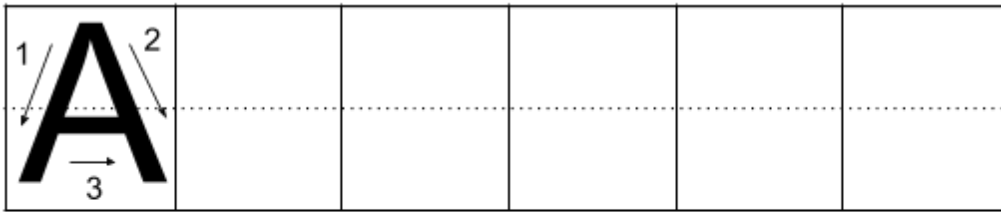

- Listen and Read.

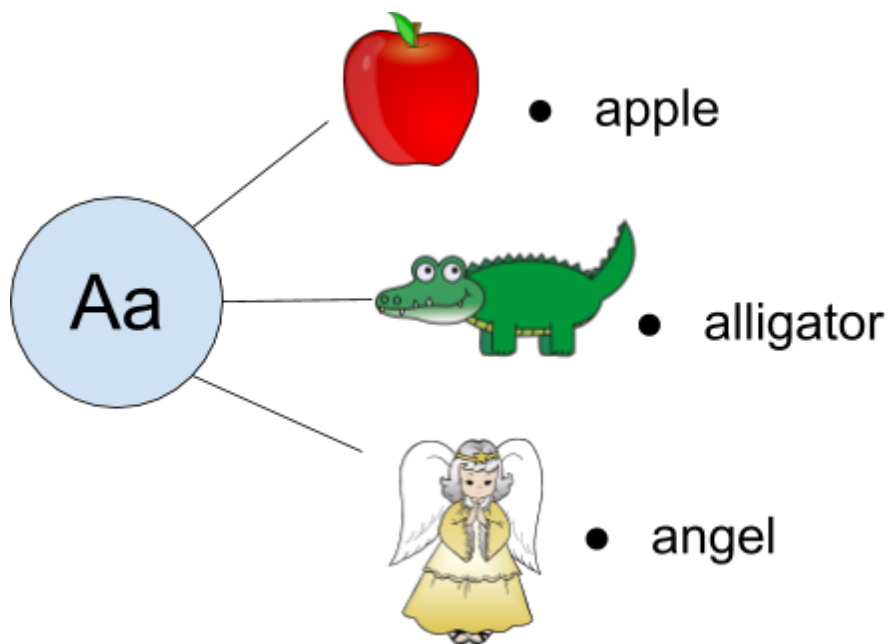

B b



- Listen to the story.

Bobo Bunny

This is **B**obo.

Bobo is a **b**aby **b**unny.
She sleeps on the **b**ed.

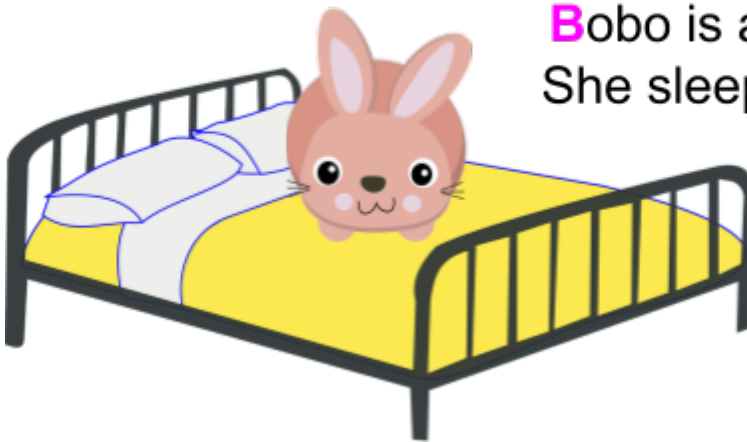

- Trace and Write.

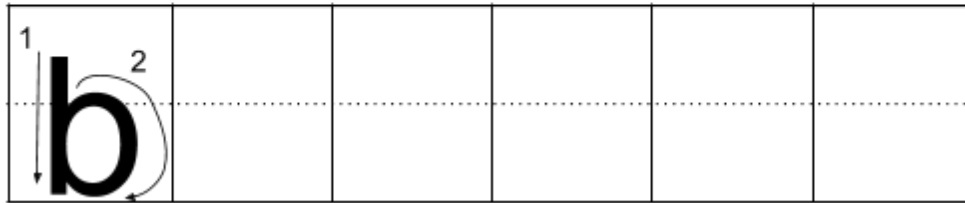

- Listen and Read.

● baby

● bunny

● bed

C c



- Listen to the story.



Candy Cat

This is **C**andy.
Candy **C**at.
She has a **c**ar.



- Trace and Write.

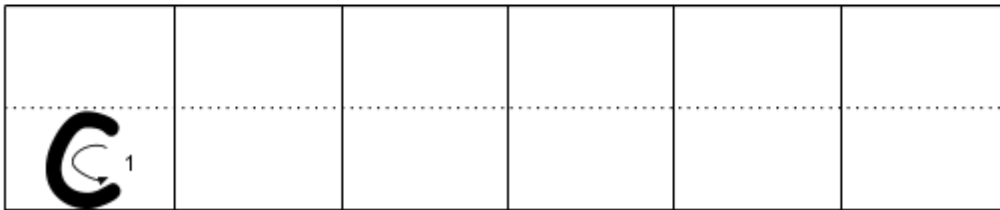
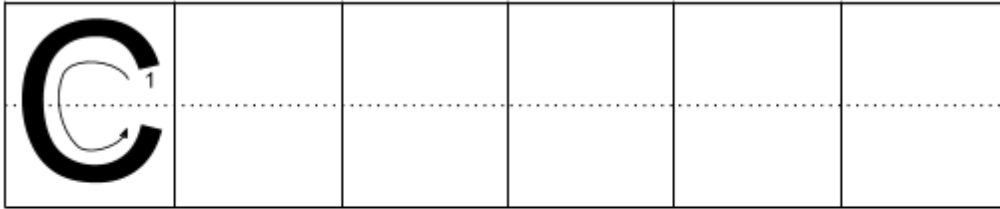

- Listen and Read.

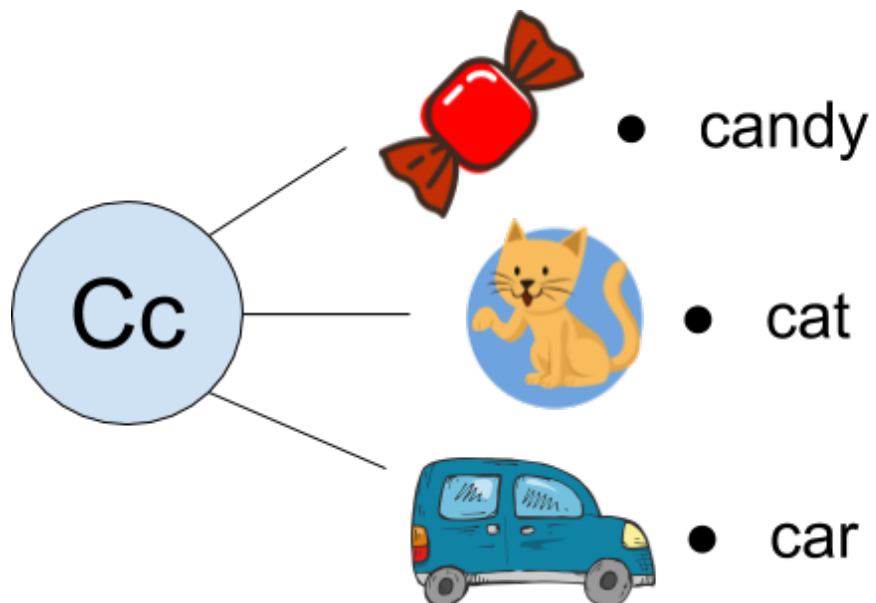

Let's practise.

(A) Circle the correct partner letters.

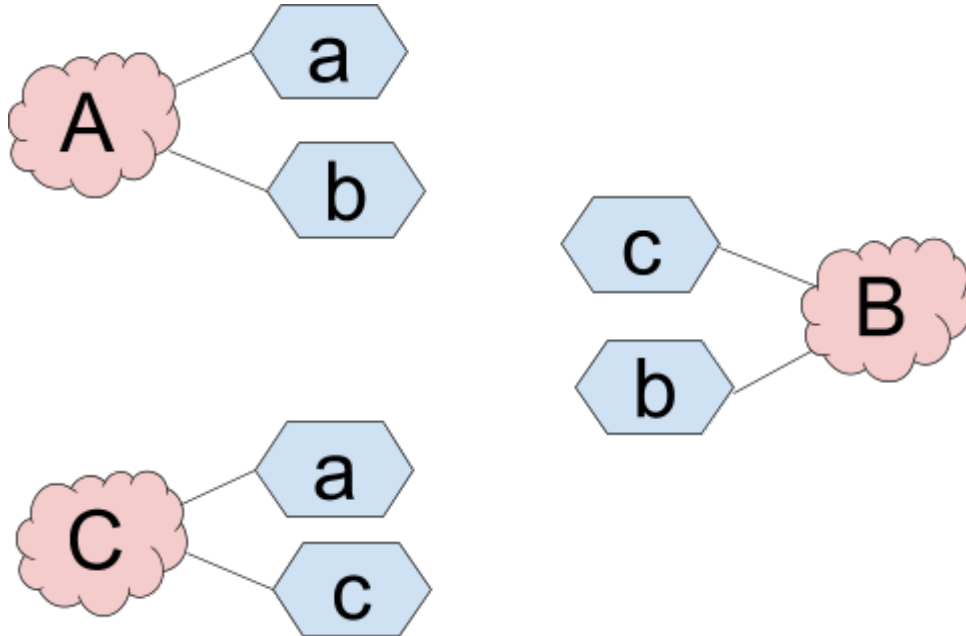

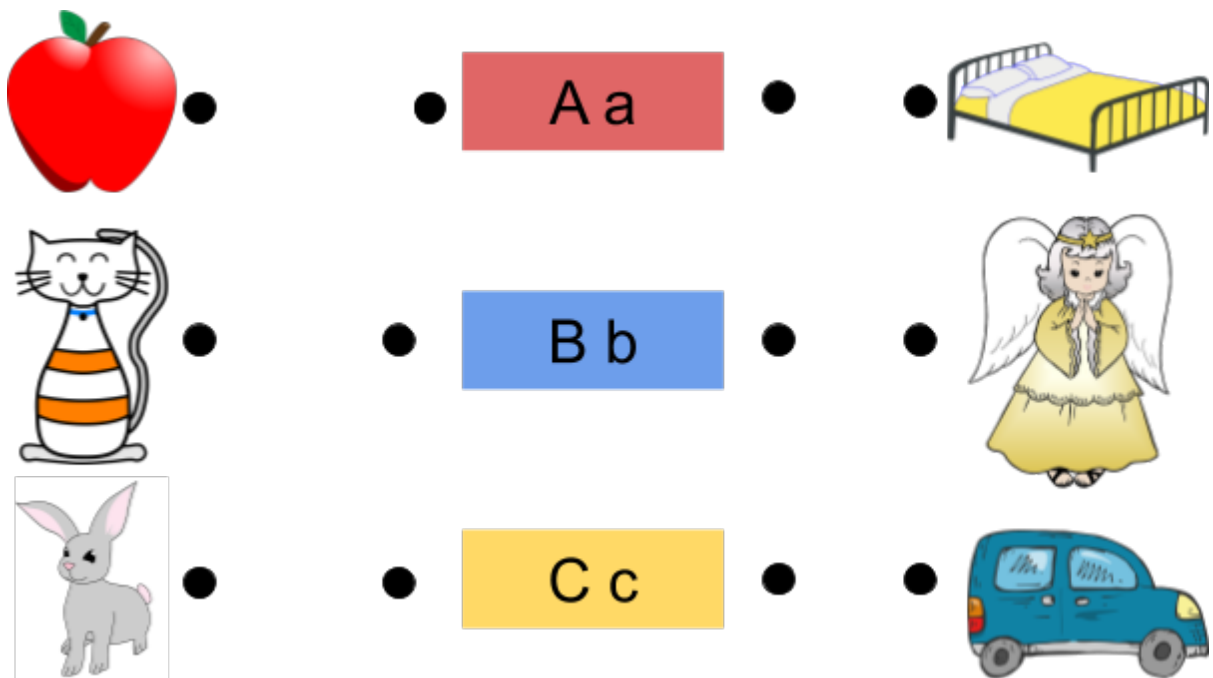

(B) Match the correct beginning sound.



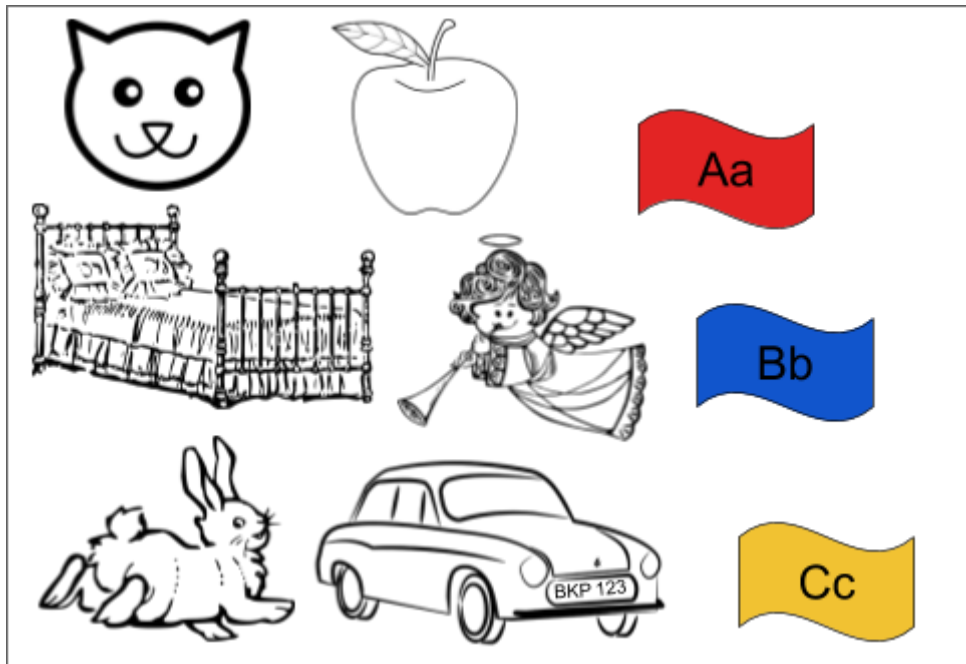





(C) Colour the pictures with the corresponding beginning sound.



(D) Read and Circle the correct picture.

1. Car   

2. Alligator   

3. Bed   

(E) Listen and Circle the corresponding word and picture.

alligator  baby  cat 

angel  bunny  car 

apple  bed  candy 

Let's have fun.

- Draw and write

Eg

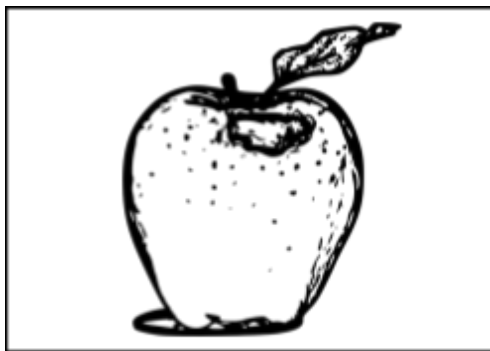

Apple

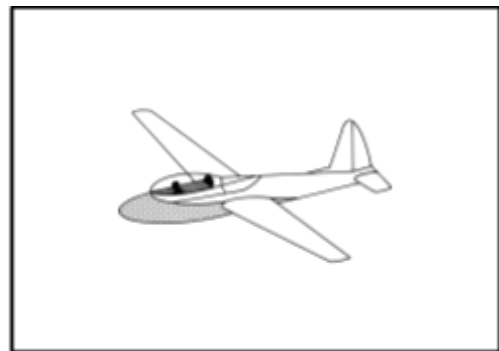

Airplane



__ngel



A_____



__unny



B_____



__andy



C_____